

**SECTION 0 - GENERAL**

**0.0 Flight Manual Approval**

**KAVANAGH BALLOONS PTY LIMITED**

**KAVANAGH**

**B-105**

**HOT AIR BALLOON**

Serial Numbers  
KB205 and up

**CASA Approved  
Hot Air Balloon  
Flight Manual**

**THIS PAGE INTENTIONALLY BLANK**

Balloon Serial Number .....

Registration Mark .....

Approved By

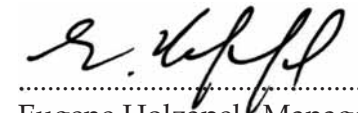

.....  
Eugene Holzapel Manager  
Certification Standards Branch  
Civil Aviation Safety Authority  
Australia

Approval Date

*29th May 2003*  
.....

**0.1 General Amendment Record**

**Aircraft Registration:**

**Aircraft Serial Number:**

**THIS PAGE INTENTIONALLY BLANK**

<b>Incorporation Date</b>	<b>Description of Amendment</b>	<b>Incorporated By</b>

**0.2 Log of Effective Pages**

**REVISION 1: April, 2003  
FROM SERIAL NO. KB205**

Page	Revision	Page	Revision
0 - 1	1	5 - 1	0
0 - 2	B l a n k	5 - 2	1
0 - 3	0	6 - 1	0
0 - 4	B l a n k	6 - 2	1
0 - 5	1	7 - 1	0
0 - 6	1	7 - 2	1
0 - 7	1	7 - 3	1
0 - 8	B l a n k	7 - 4	1
1 - 1	0	7 - 5	1
1 - 2	1	7 - 6	1
2 - 1	1	7 - 7	1
2 - 2	1	7 - 8	0
2 - 3	1	7 - 9	0
2 - 4	1	7 - 10	1
3 - 1	0	7 - 11	0
3 - 2	0	7 - 12	0
3 - 3	0	8 - 1	1
3 - 4	0	8 - 2	1
4 - 1	0	8 - 3	1
4 - 2	0	8 - 4	1
4 - 3	1	8 - 5	1
4 - 4	0	8 - 6	1
4 - 5	1	9 - 1	0
4 - 6	1	9 - 2	Notes
4 - 7	1	9 - 3	Notes
4 - 8	B l a n k	9 - 4	Notes

**THIS PAGE INTENTIONALLY BLANK**

APPROVED:  DATE: 29th May 2003

**0.3 List of Contents****SECTION 0 - GENERAL**

0.0	Flight Manual Approval	0-1
0.1	General Amendment Record	0-3
0.2	Log of Effective Pages	0-5
0.3	List of Contents	0-6

**SECTION 1 - INTRODUCTION**

1.1	Introductions	1-1
1.2	Definitions	1-2
1.3	Abbreviations	1-2

**SECTION 2 - LIMITATIONS**

2.1	Gross Certificated Weight	2-1
2.2	Rate of Climb	2-1
2.3	Envelope Temperature	2-1
2.4	In Flight Venting	2-1
2.5	Final Deflation	2-1
2.6	Flight Crew	2-2
2.7	Number of Occupants	2-2
2.8	Smoking	2-2
2.9	Altitude	2-2
2.10	Wind Speed	2-2
2.11	Mandatory Equipment	2-2
2.12	Allowable damage	2-3

**SECTION 3 - EMERGENCY PROCEDURES**

3.1	Pilot Burner Failure	3-1
3.2	Main Burner Failure	3-2
3.3	Emergency Landing Procedures	3-2
3.4	Fire	3-3
3.5	Avoidance of Low Level Objects	3-3

**SECTION 4 - NORMAL PROCEDURES**

4.1	Pre-Flight	4-1
4.2	Flight	4-5
4.3	Landing	4-6

**SECTION 5 - PERFORMANCE**

5.1	Calculation of Payload	5-1
5.2	Lift Chart for Kavanagh B-105	5-2

**SECTION 6 - WEIGHT & BALANCE**

6.1	Weights	6-1
6.2	Fuel Tank Weights	6-2

**SECTION 7 - SYSTEM DESCRIPTION**

7.1	Envelope	7-1
7.5	Fuel	7-10
7.6	Instrumentation	7-11
7.7	Radio Systems	7-12

**SECTION 8 - SERVICING**

8.1	Nature of Propane	8-1
8.2	Refuelling	8-2
8.3	Water Contamination	8-4
8.4	Fuel Tank Nitrogen Pressurization	8-4

**SECTION 9 - SUPPLEMENTS****9-1**

As the balloon empties during the landing, a light pressure should be maintained on the red rope until the balloon is empty.

### **2.6 Flight Crew**

Minimum flight crew is one person; however, there must be sufficient weight on board so the balloon can be flown in a controlled manner.

### **2.7 Number of Occupants**

The maximum number of occupants must not exceed six including the pilot.

### **2.8 Smoking**

Smoking is not allowed while the balloon is being prepared for, or during flight. A placard bearing the statement "NO SMOKING" is displayed on the inside of the basket.

### **2.9 Altitude**

Maximum permissible operating altitude is that height above ground level at which the burner fails to maintain ignition or that height, at which the maximum temperature is reached, whichever happens first. For flights above 10,000ft, oxygen must be used in accordance with Civil Aviation Regulations.

### **2.10 Wind Speed**

The balloon must not be launched in winds exceeding 15 knots at ground level, and must not be flown if there is extensive thermic activity.

### **2.11 Mandatory Equipment**

The following equipment is mandatory and must be carried each time the balloon is flown.

- a. A serviceable instrument pack. This includes an altimeter, vertical speed indicator, envelope/ambient temperature gauge. If the envelope temperature gauge is not working, or if the instrument pack does not contain one, an acceptable alternative

## **SECTION 1 - INTRODUCTION**

### **1.1 Introductions**

This Flight Manual applies only to the particular balloon identified by registration marking and serial number on Page 0-1 and contains the airworthiness limitations and essential data for the balloon. Special operations requiring additional limitations and instructions are listed in "Section 9 - Supplements" and this section shall be consulted before undertaking any such operations. For operating information not included in this Manual, reference should be made to the appropriate Operations or Manufacturer's Manuals.

The Flight Manual shall be carried in the balloon on all flights. It is the responsibility of the pilot in command to be familiar with the contents of this Manual and to comply with all directions contained herein relating to the operation of the balloon.

Amendments will be issued by the Civil Aviation Safety Authority as necessary and will take the form of replacement pages, with changes to the text indicated by a vertical line in the margin together with the amendment date at the bottom of the page. It is the owner's responsibility to incorporate in this manual all such amendments, and to enter the date of incorporation and his/her signature on the appropriate Amendment Record Sheet.

The balloon has been certificated on the basis of the equipment fitted at the time of certification. Any changes in equipment are subject to approval by the Authority. No entries or endorsements may be made in this Flight Manual except in the manner and by persons authorised for the purpose by the Authority.

## 1.2 Definitions

The following definitions shall apply throughout this Manual:

**WARNING** Operating procedures, techniques, etc., which could result in personal injury or loss of life if not carefully followed.

**CAUTION** Operating procedures, techniques, etc., which could result in damage to equipment if not carefully followed.

**NOTE** An operating procedure, technique etc., which is considered essential to emphasize.

### AIRFIELD PRESSURE HEIGHT

The Airfield Pressure Height is that height registered at the surface of an aerodrome by an altimeter with the pressure sub-scale to 1013.2 hectopascals (millibars).

**APPROVED** Pertaining to materials or aircraft parts; this includes all parts and materials which are approved by Kavanagh Balloons and CASA.

## 1.3 Abbreviations

LPG Liquefied Petroleum Gas.

CAO Civil Aviation Order.

CASA Civil Aviation Safety Authority.

FPM Feet Per Minute.

AGL Above Ground Level.

AMSL Above Mean Sea Level.

## SECTION 2 - LIMITATIONS

### 2.1 Gross Certificated Weight

Maximum gross certificated weight: **1030 kg**. This is the maximum permissible operating weight without regard to ambient conditions. The maximum operating weight for any intended flight, however, must be determined from the performance section, (Section 5).

### 2.2 Rate of Climb

Maximum allowable rate of climb is 1000fpm.

**CAUTION:** If there is damage to the envelope, which is within the acceptable limits shown in 2.12 of this section, the maximum climb rate must be reduced to 500 fpm.

### 2.3 Envelope Temperature

Maximum envelope temperature is 120 degrees celsius.

### 2.4 In Flight Venting

During flight, the parachute mode of the Smart Vent or Lite Vent, (whichever is fitted), may be used for venting air at the pilot's discretion, however care must be taken to ensure the balloon does not deflate to the point where the mouth is beginning to close.

**WARNING:** If envelope distortion is apparent, venting should be stopped and the envelope allowed to re-inflate. If the distortion persists, the balloon should be stabilised by using the burner in short bursts until the vertical speed decreases and the balloon is again fully inflated.

### 2.5 Final Deflation

**WARNING:** The Lite Vent or Smart Vent centre pull deflation system, must not be activated if the basket floor is more than six feet, (2 metres), above ground level, as the balloon will empty very quickly and could cause damage and/or injuries if this limitation is ignored.

### 3.2 Main Burner Failure

a. In the event of a main burner failure, several options are available to the pilot. If one burner fails, fly on the other burner and land as soon as possible. If both main burners malfunction, use Liquid Fire. If the Liquid Fire doesn't work, check that the tanks connected to the burner are not empty, and make sure that they are properly connected and turned on. If there is still no fuel flow, try another tank. If the fault cannot be rectified, prepare for a heavy landing. Follow the emergency landing procedure.

b. Under some conditions generally associated with low ambient air densities, (hot weather), a flame instability may develop during continuous burner operation. This will first be noticed by a change in tone of the burner flame to a "whoosh" noise. If burning is continued, the flame may be extinguished completely, however this can generally be avoided by terminating the burn at the initial change of sound, leaving the blast valve closed for a second or so, and then continuing the burn. Further occurrence of this phenomenon can be avoided by using shorter burn periods.

### 3.3 Emergency Landing Procedures

**Unpremeditated Fast Descents** - To arrest a fast descent, both burners can be used simultaneously and may, if necessary, be used continuously until the maximum envelope temperature is reached. During extreme circumstances, this course of action can be repeated, as the temperature may stabilize and show a lower reading after a short pause between burns. If the descent cannot be slowed to an acceptable rate before ground contact is made, prepare for an emergency landing.

**Emergency Landing** - All passengers should be briefed to brace themselves with knees slightly bent, hold onto one

is a fusible link warning device in the envelope, providing that an ambient temperature indicator is carried as well.

- b. One fire extinguisher and handling line.
- c. Two master tanks must be carried as minimum fuel requirement on each flight.
- d. This flight manual must be carried in the basket on each flight.
- e. Matches or a hand held igniter should be carried in the basket as a secondary means of pilot burner ignition.

#### 2.12 Allowable damage

Allowable fabric damage (Tears, holes etc.) A maximum of three holes or tears is permitted up to and including the sizes shown below in each case.

For balloons with less than 300 flight hours and no evidence of overheating, (as shown by original tell tale):

25mm - above the top of panel 8.  
 50mm- below the top of panel 8 and above the top of panel 4.  
 500mm - below the top of panel 4 down to lower edge of panel 1, (Nomex).

All others:

10mm - above the top of panel 8.  
 25mm- below the top of panel 8 and above the top of panel 4.  
 250mm - below the top of panel 4 down to lower edge of panel 1, (Nomex).

The balloon can be flown with a damaged scoop, and use of a scoop is optional.

Any damage to load tapes or suspension cables which exceeds

10% of the cross sectional area renders the envelope unairworthy and it must not be flown until repairs are made.

All major repairs must be carried out to approved data, which is contained in the Maintenance Manual or may be available from the manufacturer. The Maintenance Manual for this balloon contains a definition of major repairs.

## SECTION 3 - EMERGENCY PROCEDURES

### 3.1 Pilot Burner Failure

In the event of pilot burner failure, adopt the following course of action:

- a. Check that the vapour valve on the master tank is open and that the vapour shut-off valve at the base of the burner is open.
- b. Check that the pilot burner hose is connected correctly to the regulator on the master tank and that the regulator is not on too low a setting, and then attempt to relight the pilot burner.

If unsuccessful, continue the flight using the other burner and make a landing as soon as possible. If both pilot lights fail and cannot be relit, proceed as follows:

- c. Open one Liquid Fire valve partially and ignite the fuel coming directly out of the jet. Adjust the valve to give a flame to act a pilot burner. Fly on; using the main blast valve and make a landing as soon as possible.
- d. If for some reason it is not possible to use a Liquid Fire flame as an emergency pilot, the main blast valve can be left open and the fuel flow controlled from a tank valve. During use, the fuel supply will have to be throttled back by nearly turning off the tank valve, but leaving a small flow to ensure the fire doesn't go out. This reduced flow will cause refrigeration of the tank valve, so a close watch should be kept on this so the valve doesn't become permanently iced up and inoperable. It is best to use the valve frequently in short full power burns to limit the icing. Land as soon as possible.

basket and then mount the burner on the poles with the sockets on the burner frame. The long sides of the burner frame should be lined up with the long sides of the basket. The basket suspension cables at each corner of the frame can now be attached by placing one cable end each side of the burner frame corner bracket and sliding the karabiner through one wire thimble, the bracket and then the other. This is shown on the diagram below.

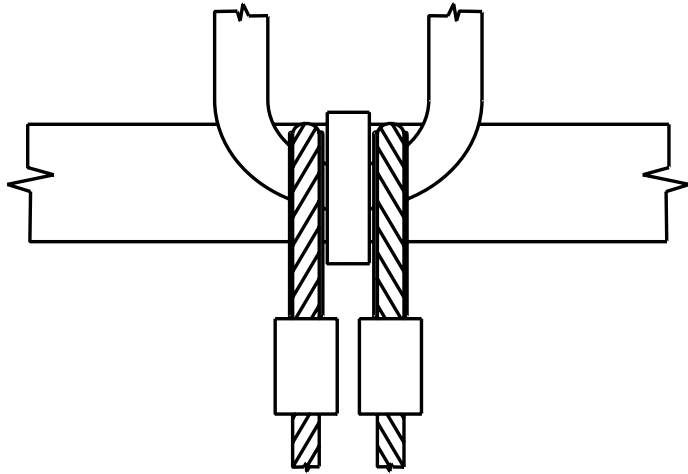

Connection of basket Attachment Points

Step 2 – strap the fuel tanks into the basket, taking care to orient the master tank to be used for inflation so that the float gauge will be in the upright position when the basket is laid on its side. This will ensure a liquid supply to the burner and vapour to the pilot light.

Step 3 - fit the padded flex-frame pole covers, ensuring the pilot hose is inside the cover and the liquid hoses are strapped to the inside for easy changeover during flight.

or more of the internal basket handles. The pilot should have all of the fuel system turned off at the tanks before ground contact is made and will alert the passengers to imminent ground contact. Immediately prior to touch down, any emergency ballast can be removed from the basket if this can be done without injuring persons on the ground. Before ground contact is made the passengers should be reminded not to leave the basket until instructed to do so.

### 3.4 Fire

**On the Ground** - Turn off fuel at the main tank valves, use the fire extinguisher to put out fire. If this action proves unsuccessful after 30 seconds or so, evacuate the crew from the immediate area because of the danger from fuel spraying from relief valves and a possibility of explosion from overheated fuel tanks.

**In the Air** - Turn off fuel at main tank valves. Put out the fire with fire extinguisher. If safe to relight pilot burner proceed as normal and make a landing as soon as possible. If unsafe to relight the pilot burner, prepare to make an emergency landing.

### 3.5 Avoidance of Low Level Objects

If a collision with an object on the ground appears possible, the pilot must be quick to make the decision whether it is better to climb or descend.

**Climb** - The situation must be assessed quickly, and if the decision to climb is made it must be made only if the pilot is certain that the obstacle can be cleared.

**NOTE:** from stable flight the balloon responds faster when a descent is initiated than when a climb is started.

**Descent** - If the decision to descend is made, brief the crew and carry out an emergency landing using the parachute mode of the vent to increase the rate of descent if necessary. During the descent shut-off fuel as described in emergency landing procedures.

**Powerlines** - If contact with power lines is unavoidable, descend as fast as possible so that the contact is made with the envelope and not with the basket assembly.

## SECTION 4 - NORMAL PROCEDURES

### 4.1 Pre-Flight

a. **Weather** - If mandatory, or at the pilot's discretion, obtain a meteorological forecast for the flight area. This can be checked locally before the flight by release and observation of a helium filled pilot balloon.

b. **Fuel** - Check fuel quantity is adequate for the planned flight. There are two ways to check fuel.

i. The fixed liquid level gauge or bleeder valve has a dip tube which is long enough to allow liquid to discharge from the valve when the tank is 80% full or over. When filling tanks this level should not be exceeded.

ii. Weighing is the most accurate way of measuring fuel quantity when the level is higher than that shown on the fuel gauge and lower than 80%. LPG weighs .5kg per litre at 16 degrees Celsius so a simple calculation is necessary to determine quantity after the tank is weighed. See Section 6 for tank weights.

c. **Site Selection** - If the surface wind is above five knots a sheltered site should be considered for inflation. Any site selected even in near calm conditions should be free of down-wind obstructions for 200 metres, and more if windy.

d. **Assembly**

Step 1 - locate the basket so that when it is laid over for inflation, the burner will be pointing downwind. Slot the four nylon flex-frame poles into the sockets in the top edge of the

of the envelope and this will be seen by inward movement of the lower part of the envelope.

**WARNING:** The Lite Vent is a much more effective in flight vent than any other type and extreme care must be taken when learning to use it. Attention is drawn to SECTION 2 - limitations Para. 2.4

If turbulence is encountered during flight the Lite Vent panel can be securely held in place to prevent leakage, by application of a little force to the white reset rope.

b. **Rotation Vents** - may be used in flight to orient the balloon as the pilot wishes. NOTE: Excessive use of the rotation vents will cause a significant rise in fuel consumption.

c. **Fuel Management** - Each pilot must have a fuel management system that works. The only suggested procedure is to ensure there is an adequate fuel supply available to both fuel supply hoses at all times during flight, so if an emergency need for maximum power arises, there will be fuel available in sufficient quantity to meet the need.

d. **Burner** - The burner will be most effective if used in need for maximum power arises, there will be fuel available in sufficient quantity to meet the need.

### 4.3 Landing

a. The rotation vents should be used to orient the basket so that a long side is across the direction of travel. This is imperative to ensure a comfortable attitude for landing.

b. It is recommended that both the pilot burners and the main burners are off before ground contact is made.

c. i. **SMART VENT** - If a Smart Vent is fitted, the Smart Vent centre pull (Red Rope) should be fully opened once the balloon is within six feet (2 metres) of ground level at the pilot's

Step 4 - it is important to ensure that there are no leaks in the fuel system before the pilot burners are lit. Fit the main supply hoses to the liquid outlet valves and pressurise the system. If no leaks are apparent the pilot system can be connected and lit using the piezo igniters. A short burner test on each tank to be carried in flight is recommended to ensure a liquid supply from all tanks. The fuel system should now be shut down for the initial stages of the inflation.

Step 5 - the basket should be laid on the side with the burner pointing downwind. The envelope bag is placed downwind of the burner and the bottom portion removed from the bag. Total removal of the envelope from the bag is not recommended until after the connection to the basket is made, otherwise a wind gust could partially inflate the balloon and cause it to be blown away. The envelope cables are connected to the karabiners in four groups ie. When facing downwind, fit 1 - 6 to the top left corner of the burner frame, 7-12 to the top right corner, and continue with the same system of numbering for the rest of the rigging. These numbers are marked on the rigging cover at the top of each cable. Connecting the rigging to the burner frame in this order and position ensures the scoop is on the underside during inflation. Make sure that all the karabiner screwgates are in the closed position.

Step 6 - Set the altimeter for correct QNH or QFE setting and check the electric variometer and temperature gauge for indication of correct operation, ensuring the cable connection to the envelope, (if applicable), is secure.

Step 7 - Connect the deflation system control lines to the basket at the appropriate places. If Smart Vent is fitted, the centre pull rope is red and the parachute/reset rope is white. If Lite Vent is fitted, the parachute vent rope is red & white flecked, the reset rope is white and the centre pull rope is red. Connect the rotation vent cords at the same time.

e. **Pre-Inflation Checks** - Re-check all the points made in (a) to (d) of this section. Check that at least one extra source of ignition for the pilot burner is in the basket, ie. striker or matches or both. Check that all equipment such as handling line and fire extinguisher is on board as well as any other equipment to be carried. Make a detailed check of the load to be carried against the instructions set out in SECTION 5.

f. **Inflation- Recommended Procedure** - One crew member should be appointed to the crown line, one other to each side of the mouth to hold it open for filling by fan. The fan is started and at this point the balloon pilot should walk into the balloon taking all the excess of both vent ropes to above the lower pulley. As the balloon inflates the pilot should visually inspect the condition of the envelope and ensure that the vent rope and the rigging are not in a position to tangle as the inflation progresses.

The crown crew member should attach all of the temporary vent tabs on the vent panel as the balloon inflates. When the balloon is about half full with cold air, the tank mentioned in Part (d) Step 2. is turned on and the pilot burner is lit. The pilot at this stage will give several short burns to cause the balloon envelope to lift off the ground a little so the fan can complete filling. The crown person should only apply enough weight on the crown line at this time to stop the crown from drifting back towards the basket in calm conditions and no weight at all if there is any wind. When the balloon is almost completely full on its side, the pilot will signal to the crown crew to apply weight on the line by means of one continuous burn, the crown will rise rapidly if no weight is applied and the task of the crown crew is to let it rise slowly to the upright position. In calm conditions the crown crew's job is harder than during windy conditions when no pressure on the crown is needed as the wind is quite an effective anchor for the crown.

#### g. **Pre- Launch Checks**

- i. After the balloon is upright and before take-off, activate the parachute mode white rope to release all of the Velcro tabs around the outer edge of the vent panel. When it is certain the Velcro tabs are all released, the red Smart, centre pull mode can be tested, by first pulling the red rope, then resetting the vent panel by pulling down on the white parachute rope.
- ii. Check that both fuel supply hoses are delivering fuel satisfactorily.
- iii. Ensure that passengers are properly instructed.
- iv. Make sure that all points in (a) to (e) of this section have been satisfied.

### 4.2 Flight

a. i. **Smart Vent Parachute Mode** - the parachute vent is a effective control and should be used with caution until the pilot becomes familiar with its effect on manoeuvring. Prolonged opening of the vent will cause partial deflation of the envelope and this can be seen by the inward movement of the lower part of the envelope. The parachute activation line is white and is also used for resetting the Smart Vent during landing. Attention is drawn to SECTION 2 - Limitations Para. 2.4 & 2.5

ii. **Lite Vent Parachute Mode** - the Lite Vent is a very effective control and should be used with caution until the pilot becomes familiar with its effect on manoeuvring.

There are three control lines for the Lite Vent. One is coloured white and this is used to extend the panel to its full diameter to allow for a complete seal. The second line is red & white flecked and this is used for in-flight venting. The third line is red and operates the centre pull for final deflation. Under normal conditions the vent will reseal by air pressure and from the action of the counter weight at the base of the reset shroud lines. However the white reset line is there to assist in spreading out the panel to its full diameter if necessary.

Prolonged opening of the Lite Vent will cause partial deflation

**5.2 Lift Chart for Kavanagh B-105**

Envelope temperature, 100 Degrees Celsius, I.S.A.conditions

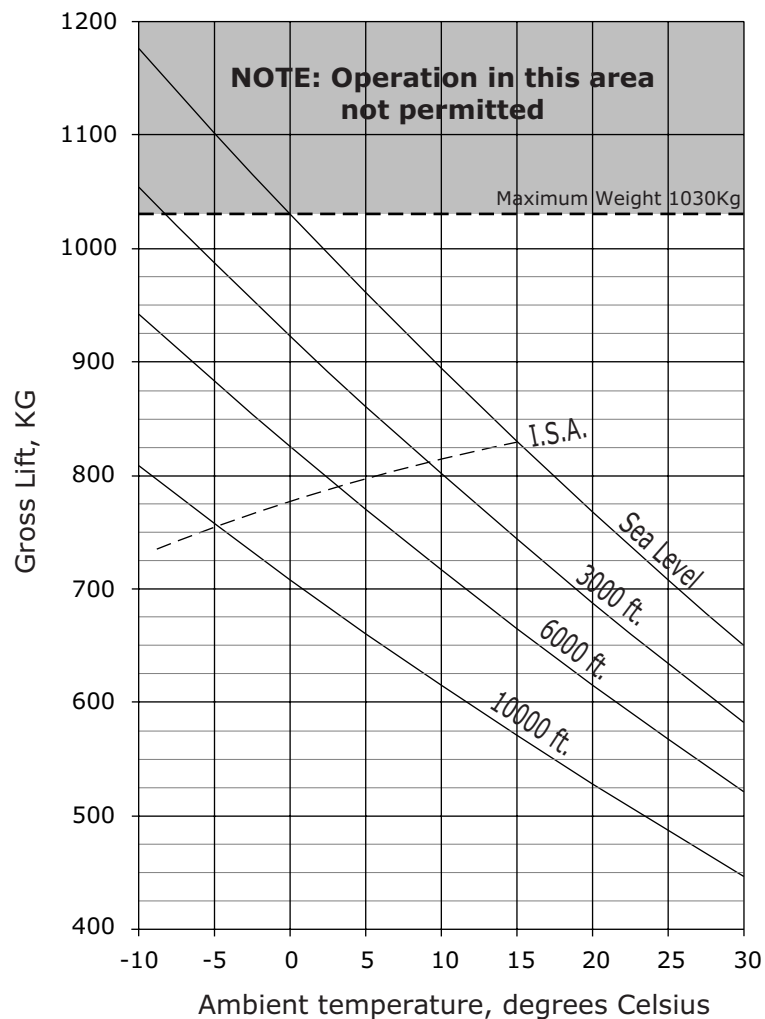

NOTE: B-105 maximum weight 1030kg.

discretion during the landing operation. During the final landing, the Smart Vent will not reseal itself unless the pilot takes some action to cause it, so there is no need to maintain pressure on the red deflation line.

ii. **Lite Vent** - If a Lite Vent is fitted, the centre pull (Red Rope) may be fully opened once the balloon is within six feet (2 metres) of ground level at the pilots discretion during the landing operation. During the final landing, the pilot should maintain a little weight on the red deflation rope to ensure the vent panel does not partially cover the hole during the deflation.

d. Once the balloon has stopped and is fully deflated, the pilot should check to ensure all the fuel valves are turned off and that fuel pressure is released from all parts of the fuel system.

## SECTION 5 - PERFORMANCE

### 5.1 Calculation of Payload

#### Instructions for use of Load Chart

- a. Find ambient temperature at takeoff site.
- b. Determine the height, (above sea level), of the take off site, and set the altimeter subscale to 1013 millibars. If the altitude shown is greater than the height of the actual take off site, this difference must be added to the planned maximum altitude. If the altimeter shows a lesser height, the difference should be subtracted from the planned maximum altitude. This calculation allows for daily differences in atmospheric pressure.
- c. Decide maximum planned flight altitude.
- d. Enter the Load Chart graph at ambient temperature scale and move vertically to altitude of takeoff site.
- e. Move diagonally to maximum flight altitude ie. parallel to ISA line.
- f. Move horizontally across to the gross lift scale at the left side.
- g. Read off gross lift from the scale at this point and this weight is the total maximum weight that can be carried at the maximum planned flight altitude.
- h. From the gross maximum weight, subtract the weight of the balloon system and fuel as worked out from 6.1 & 6.2 and the remaining figure is the available load.

**THIS PAGE INTENTIONALLY BLANK**

The two diagrams following, show the parachute mode and the centre pull Smart Vent. The white reset rope is used to extend the panel to its full diameter as needed.

The figure below shows the vent open in the parachute mode. If the white parachute rope is pulled, the edge of the vent will be pulled inwards and down allowing air to escape. This Parachute mode is for in flight venting as well as partial deflation during intermediate landings.

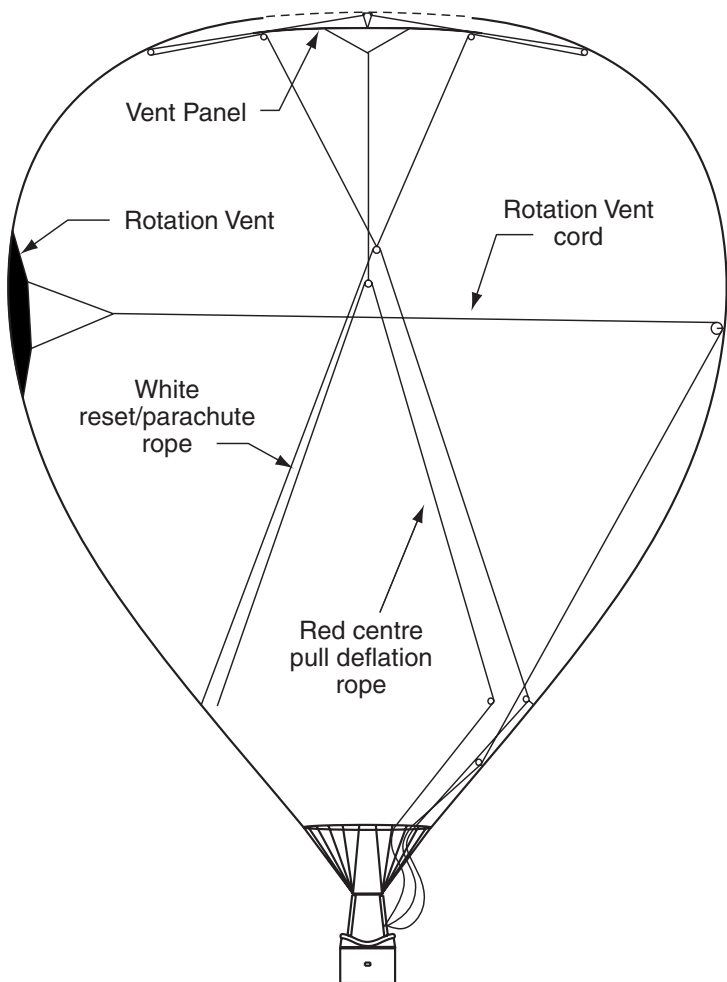

## SECTION 6 - WEIGHT & BALANCE

### 6.1 Weights

BASKET WEIGHT, Includes:

Burner, Model: \_\_\_\_\_ S/N: \_\_\_\_\_

Load Frame Size \_\_\_\_\_

Basket, \_\_\_\_\_ x \_\_\_\_\_ S/N \_\_\_\_\_

Instrument pack \_\_\_\_\_ S/N \_\_\_\_\_

4 Flex-Frame poles \_\_\_\_\_

4 Pole covers \_\_\_\_\_

Tank straps \_\_\_\_\_

Fire Extinguisher \_\_\_\_\_

Handling line \_\_\_\_\_

Floor Padding \_\_\_\_\_

Internal Padding \_\_\_\_\_

Sub-Total = \_\_\_\_\_

ENVELOPE Includes:

Envelope \_\_\_\_\_

Scoop \_\_\_\_\_

Sub-Total = \_\_\_\_\_

Envelope Carry Bag \_\_\_\_\_

TOTAL WEIGHT = \_\_\_\_\_

Signed: \_\_\_\_\_ Date: \_\_\_\_\_

Aircraft Weight Control Authority No \_\_\_\_\_

## SECTION 7 - SYSTEM DESCRIPTION

### 6.2 Fuel Tank Weights

Tanks with AFL's	Empty Weight	Full Weight
Kavanagh 55, Master	21	43
Kavanagh 55, Slave	20.1	42.1
Kavanagh 76, Master	23.3	53.7
Kavanagh 76, Slave	22.5	52.9
Kavanagh 82, Master	24.6	57.4
Kavanagh 82, Slave	23.7	56.5
Tanks without AFL's	Empty Weight	Full Weight
Kavanagh 55, Master	20.5	42.5
Kavanagh 55, Slave	19.2	41.2
Kavanagh 76, Master	22.9	53.3
Kavanagh 76, Slave	21.6	52
Kavanagh 82, Master	24.2	57
Kavanagh 82, Slave	22.9	55.7
Worthington 47 Master	15.3	34.3
Worthington 47 Slave	14	33

**Note:** Weights are in Kg, and all tank weights include padded jackets, and handle guards.

### 7.1 Envelope

The B type envelope is of the "bulge gore" design and is made up of 24 vertical segments (gores), which have a slight tailored excess of fabric horizontally between each vertical load tape.

The balloon envelope is manufactured from high tenacity rip-stop nylon fabric which is coated so that the whole structure remains as airtight as possible. All the major loads are taken on polyester webbing both horizontally and vertically. These allow for a wide margin of safety as well as providing suitable anchor points for the attachment of payload.

**Smart Vent.** The two main envelope controls, the manoeuvring vent and deflation device, are incorporated into one system called the Smart Vent. This consists of an oversized circular panel, which sits below a hole in the crown and is held in place by a series of cords and by internal pressure from the lifting gases. It is opened using either of two control lines, which are fed through a system of pulleys to the basket.

For in flight venting the outer edge of the panel is pulled inwards and down to allow controlled venting of hot air. This in flight venting method is called the parachute mode and a white rope is used.

For final landing, a second control line, coloured red is pulled by the pilot. This causes the centre of the circular panel to be pulled down into the balloon while radially diminishing the size of the panel. This final landing system is called the Smart Vent and should only be used during the final landing approach when the balloon is within six feet (2 metres) of ground level, as the balloon will empty very quickly and could cause damage and/or injuries if activated at a greater height.

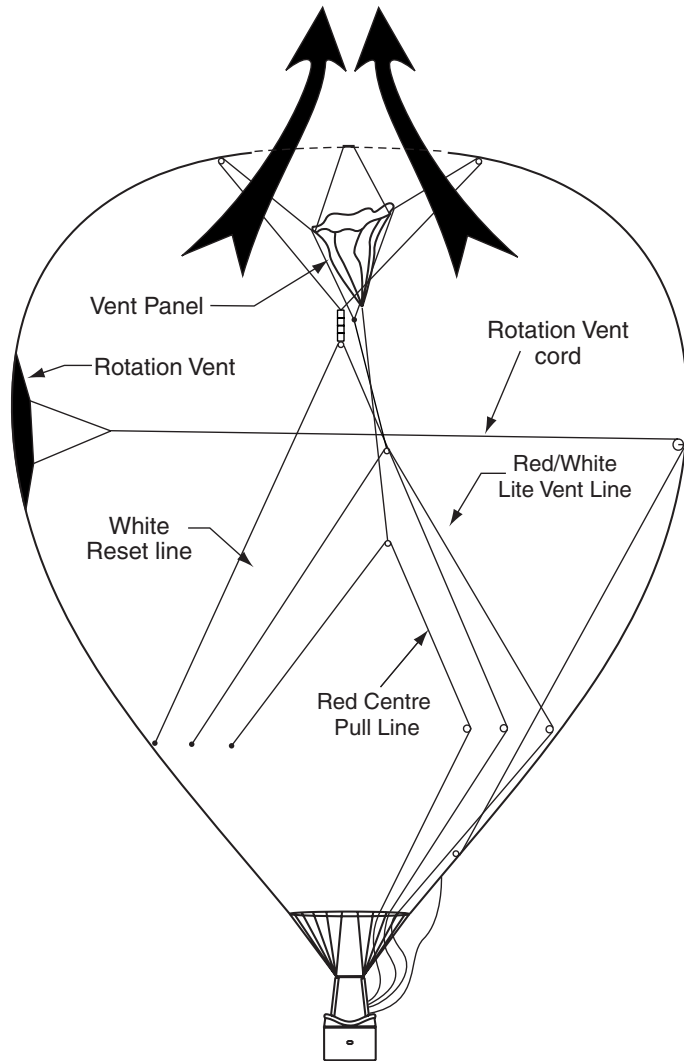

The figure above shows the Lite Vent in centre pull mode for landing, within six feet (2 metres) of ground level. As the centre of the panel is pulled downwards, the outer edge also moves towards the centre, causing a very large vent aperture.

**Intermediate Landings-** The red flecked Parachute rope may be used for partial deflation during intermediate landings. This

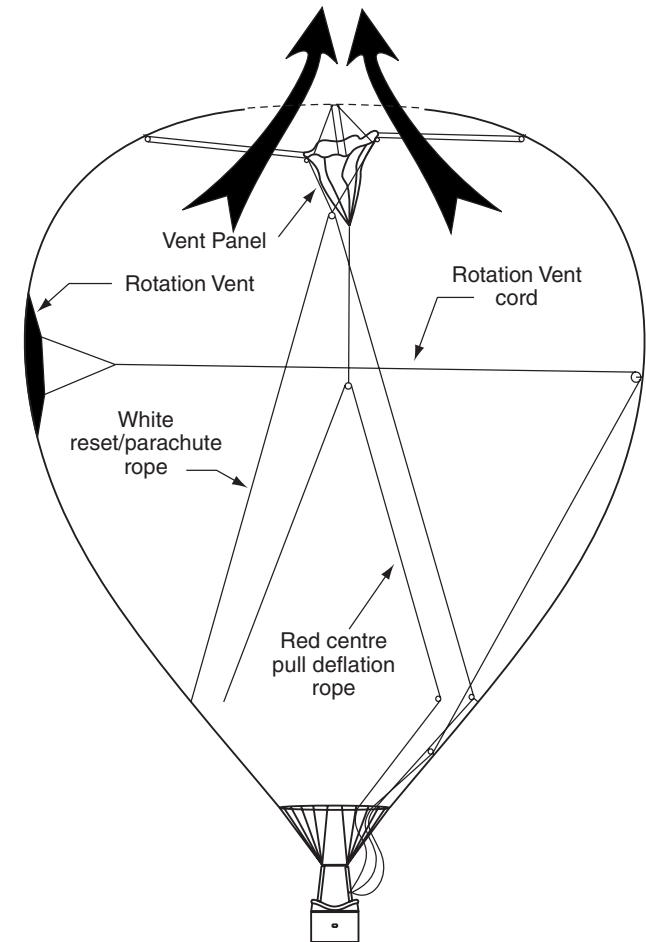

The figure above shows the Smart Vent fully open as used during the landing phase, within six feet (2 metres) of ground level. The red centre pull rope is used for landing. As the red rope is pulled in, the white reset rope is drawn back up into the balloon. This is the reason there is excess white rope stored in the pouch during flight.

**Intermediate Landing.** The white parachute/reset rope is used for partial deflation during intermediate landings, or alternatively, the centre pull may be used then reset using the white rope.

**Lite Vent.** The two main envelope controls, the manoeuvring vent and deflation device, are incorporated into one system called the Lite Vent. This consists of an oversized circular panel, which sits below a hole in the crown and is held in place by a series of Vectran cords, connected to a counter weight and by internal pressure from the lifting gases.

Lite Vent is opened for landing using a red control rope which is connected to the centre of the vent panel. For in-flight venting a second control rope, red flecked, is used. This parachute rope is connected to the edge of the vent panel via a set of parachute style shroud lines, and fed through a system of pulleys to the basket. A third, white coloured control rope is used to assist in resetting the vent and maintaining control over leakage during turbulence.

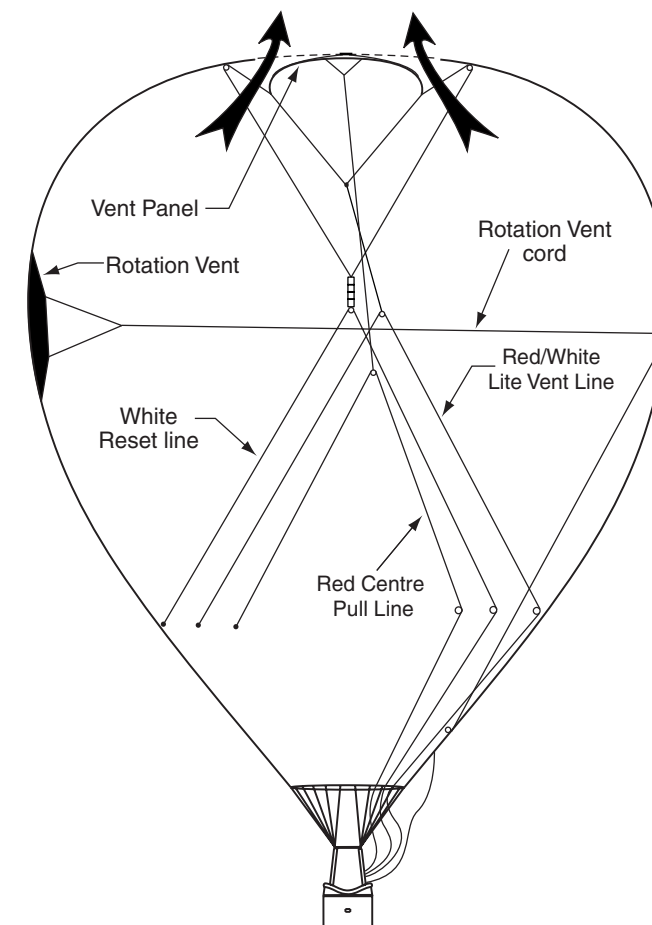
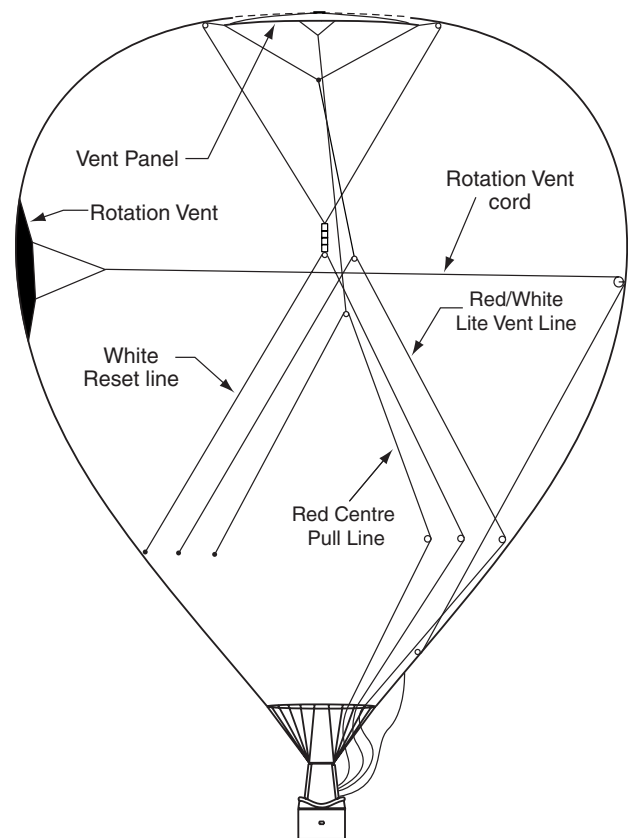

The three diagrams including the one on Page 7-4, show the Lite Vent, first in the closed position, second in the parachute mode and third in the centre pull mode. The white reset rope is used to extend the panel to its full diameter as needed.

The figure above shows the Lite Vent in parachute mode for in-flight venting. This control rope is red flecked in colour. Care must be taken to ensure the vent is not held open for too long. The pilot must look upwards during prolonged venting to ensure the vent is not overused.

## 7.4 Fuel Tanks

Fuel tanks are Mytton 55litre stainless steel, Kavanagh STPV 55litre, 76 litre, and 82litre stainless steel, or Worthington 44 litre, aluminium propane tanks. Two master tanks and one slave are the minimum required for flight. Extra slave tanks may be carried as flight requirements dictate. All tanks are supplied with a liquid outlet valve (slave type) and some also have a vapour outlet valve with a pressure regulator for the pilot burner system (master type). All tanks have a safety relief valve and a fuel quantity gauge which shows decreasing fuel quantity from 32% down as well as a fixed liquid level gauge. This is a bleed screw which, when opened will valve liquid from the tank if the level is over 80%, the safe level for a full tank.

Some tanks may be fitted with an automatic fill limiter. See Section 8 - Servicing.

Liquid capacity of each tank is:

Tank type	Capacity (litres)	Usable
Mytton 55	44	43
Kavanagh STPV 55	44	43
Kavanagh STPV 76	61	59.5
Kavanagh STPV 82	66	64.6
Worthington	38	37

## 7.5 Fuel

Any commercially available propane is suitable. This includes propane/butane mixtures commonly used to fuel automotive vehicles, with the proviso that the fuel pressure shown at the pre-flight burner test when using such a mixture is not below 350kpa.

is a very effective vent and will cause a dramatic loss of lift if fully opened. Alternatively, the centre pull line may be partially activated and the panel can be reset by pulling down on the red flecked parachute line. This will re-inflate the vent panel and cause it to re-cover the hole again very quickly.

For in flight venting the outer edge of the panel is pulled inwards and down to allow controlled venting of hot air. The vent will reseal automatically from air pressure when the rope is released.

**Rotation Vents.** (see Diagram on page 7-2) These vents allow the pilot to rotate the balloon in either direction and are useful to maintain the orientation of the long side of the basket across the direction of travel during the landing. The ends of the two activation cords are 25mm wide webbing. One is coloured white and the other is black. When facing outwards from the basket, the white strap is to the right and will cause the balloon envelope to rotate towards the right, while the reverse applies to the black coloured strap.

The lowest panel in the balloon next to the envelope mouth is made from Nomex fabric, which has a very high resistance to heat and prevents unnecessary burn damage, which may occur during inflation.

The base of the envelope is connected to the burner frame by stainless steel wires in four groups each terminating at a 3000kg steel karabiner.

**Scoop Skirt.** This is an extension, made from Nomex, of half the base of the balloon, which tapers down at the bottom to about 600mm wide at the burner frame. This skirt acts as a scoop for air entering the envelope and is very efficient for high wind takeoffs, and also for tethered flights.

## 7.2 BASKET

The basket can be 1.4 - 1.6 metres long and 1.0 - 1.1 metres wide. It is constructed of cane with the floor fully woven around cane and timber slats. Bolted through the floor are hardwood runners, which protect the floor from damage during landing and ground handling.

The suspension system consists of stainless steel wire rope slings, which pass through and under the floor of the basket and connect to each of the four suspension attachment points on the burner load frame. To assist in supporting the load frame and burner during inflation and landing, there are four nylon flex frame support poles which fit into stainless steel sockets on both the burner load frame and the top edge of the basket.

The bottom edges of the basket are covered with tough chrome hide to prevent scuffing the wickerwork and the edge of the floor. The top edges of the basket are covered with cushioned leather for passenger comfort.

As standard the basket has a fire extinguisher and handling line fitted to the sides.

## 7.3 BURNER SYSTEM

The Series 3 double burner unit consists of two single barrel natural draught, high-pressure, propane burners. These are mounted on a tubular frame and are gimballed to allow the burners to swivel during use. There is a friction control, which will allow movement when desired but should be adjusted so the burner will not tilt when unattended.

The double burner has an interconnecting pipe and isolating valve (called a cross flow valve), so that the one main burner valve may activate either one or two burner units.

The main on/off blast valves are Worcester 44 ball valves, which are fitted to purpose made manifold blocks at the base of the burner cans. A pressure gauge is fitted to the upstream or fuel tank side of the main valve and this shows the operating pressure of the burner as well as indicating the presence of fuel pressure in the hose.

Ignition of each main burner is achieved by use of a pilot burner. The pilot burner is a separate system from the main burner. It draws from the vapour valve on the master tank, which is fitted with a pressure regulator to reduce the line pressure to approx. 100kpa. The pressure may be varied to suit the pilot by adjusting the knob at the end of the regulator on the tank. Clockwise will increase the pressure. Care should be taken to not operate at too low a pressure, as there may be a danger of accidentally extinguishing the pilot flame.

The pilot burner is a tube and cup arrangement in the bottom of the main burner and is fitted with a piezo electric igniter for ease of operation. There are two separate vapour supply hoses, so the double burner is separated into two redundant units.

A secondary burner is supplied as a standard feature. This is called "Liquid Fire" and is a system where liquid propane is fed directly into the burner can beside the pilot burner, bypassing the heat exchanger coil. It is operated by a Prestige ball valve and is only recommended for use in stable flight. It has a low noise level and is intended primarily for over flight of animals.

When operating Liquid Fire the valve should be opened slowly to ensure ignition of the fuel before it is opened fully. This secondary burner should only be used when there is a real need such as close proximity of stock, as it will produce an amount of carbon powder which will dirty the inside of the balloon and cause the appearance to deteriorate.

## 8.2 Refuelling

Although fuel tanks are normally filled at approved filling stations, it is common at balloon meets for the refuelling to be done by the balloonist. Therefore it is important to be familiar with refuelling procedures.

There are two different procedures which may be used, depending on whether or not the tanks are fitted with automatic fill limiters.

### Filling Tanks without Fill Limiters

- a. Before refuelling, an inspection should be made to ensure there is no damage or wear to the fuel system which could be a safety hazard.
- b. Ensure there are no ignition sources present. e.g. open flames, running engines, lit cigarettes, mobile phones, radios etc. Wear suitable protective clothing, (long sleeve cotton shirt and leather gloves), and have two fire extinguishers on hand. Do not wear synthetic clothing unless it is made from Nomex.

All cylinders to be filled should be electrically earthed during refuelling, or during venting of vapour for any reason.

- c. Connect the end of the filler hose to the liquid outlet, (1 1/4" Acme thread safety connector), and open the liquid outlet valve, as well as the fixed liquid level gauge.
- d. If a pump is being used, the fixed liquid level gauge should only be turned on a little. If the filling method is by decanting without a pump, there needs to be a higher flow from the fixed liquid level gauge so the pressure in the tank to be filled remains below that of the supply tank.
- e. The fixed liquid level indicator has a dip tube inside the tank, the bottom of which is at the level of 80% of the total volume of the tank. When this level is reached during filling,

## 7.6 Instrumentation

Several types of instrument pack may be used. These are shown below.

The Ball 655 balloon pack has an 0-20,000ft. digital altimeter, a two scale electric variometer and an envelope and ambient temperature indicator. This pack is fitted in a padded bag with Velcro ties.

The Ball 659 balloon pack is the same as the 655 except there is no ambient or envelope temperature gauge fitted. And this pack must be used with a separate ambient thermometer.

The Ball M55 balloon pack is a new model and replaces the 655 pack. It has updated electronics and stores elapsed flight time and peak envelope temperature.

Flytec 3040 balloon pack has a digital altimeter, variometer and remote envelope temperature sender. Mounting is by bracket or Velcro straps. Flytec 4005 and 4010 are similar to the 3040 except there is no envelope temperature sensor fitted.

Brauniger AV-Classic and IQ Classic both feature a digital altimeter and variometer. Mounting is by bracket or Velcro straps. Brauniger AV-Competition and Competition IQ, both have the same features as the Classic, but also have an inbuilt barograph. An additional feature found on the Competition IQ GPS, is a socket for connection of a GPS, the data from which is stored alongside the barograph data. This gives a complete picture of each flight, showing time, altitude and position.

Aircotec Piccolo Plus is a digital altimeter and variometer. Mounting is by Velcro strap.

Aircotec Piccolo Plus ACT5000 is the same as the Piccolo Plus, but has an infra red envelope temperature as well as the standard features.

If an envelope temperature sensor is not fitted, a melting link warning device must be used.

### 7.7 Radio Systems

No radio system is fitted as standard, however approved handheld VHF and/or UHF radios may be used from time to time as the flight requirements dictate.

## SECTION 8 - SERVICING

This section contains information on recommended procedures for refuelling and storage of the fuel system.

### 8.1 Nature of Propane

Propane remains in liquid form only when contained under high pressure or at extremely low temperatures. Propane droplets vapourize very quickly at room temperature and this causes an extreme cooling effect. Severe freeze burns can occur from contact with liquid propane which boils at  $-43^{\circ}$  Celsius.

Propane in its gaseous state is approximately 1.5 times heavier than air. Propane gas will therefore collect at the lowest unventilated point. It is acceptable to refuel tanks in a wicker basket, because the open wicker provides adequate ventilation for gas to escape. If the basket has a plywood floor there are drain holes to allow any build up of gas to escape. It is important to ensure these holes are never blocked.

The following table may be used as a guide for vapour pressure of different LPG types at varying ambient temperatures.

**NOTE:** these temperatures are not ambient air temperatures. The table shows the temperature of the liquid contained in the tank.

Temp. °C	Pressure Kpa		
	Propane	Butane	50/50 mix
0	380	0	210
5	460	20	270
10	550	40	330
15	660	70	400
20	770	110	480
25	880	150	560
30	1010	190	650

If a master tank is to be returned to use as a vapour supply for pilot burners after having been pressurized with nitrogen, it should be vented as described above then emptied and refilled with the fixed liquid level gauge (bleed valve) open during filling.

Extra care should be taken when this tank is first used to ensure the pilot burner operates correctly and provides a stable flame.

It is important that the use of high pressure nitrogen cylinders is carried out with reference to the safety, handling and storage guidelines in place for these cylinders.

Local and National regulations concerning the use of these cylinders must be complied with. The supplier of the nitrogen cylinders will be able to supply the necessary information.

liquid will spurt out, giving a visual indication that the tank is full. The fuel flow, tank outlet valve, and the fixed liquid level indicator valve should be immediately shut off.

f. Never allow a fuel tank to be filled above its normal liquid level as indicated by the fixed liquid level indicator. This could allow expansion from an ambient temperature rise to fill the tank completely and cause the unexpected release of propane from the pressure relief valve.

g. Pressure between the tank outlet valve and the 1 1/4" self sealing coupling on the tank should be released immediately after the filler hose is removed from the tank.

#### **Filling Tanks Fitted with Fill Limiters**

a. Follow the steps set down in parts a, b, & c of the preceding instructions.

b. Tanks with a fill limiter fitted must be pump filled for the fill limiter to operate. The fill limiter has a 1 3/4" Acme thread, which is the same as the bowser end of an automotive pump at a service station.

c. The pump hose is screwed directly onto the fill limiter. The time spent refuelling is greatly diminished when filling through this fitting. When the fuel level reaches 80%, the flow is automatically shut off and the pump hose may be immediately unscrewed and switched to the next tank.

d. The bleed screw on the fixed liquid level indicator is not to be opened when filling through a fill limiter.

**NOTE: Notwithstanding the advice given in this section, you are reminded it is the pilot's responsibility to ensure compliance with any laws governing the refuelling of LPG containers.**

### 8.3 Water Contamination

If water contamination is suspected, a couple of teaspoons of Methyl Alcohol, (Methylated Spirits), should be added to each tank. The simplest method is to pour the Methyl Alcohol into the filler hose before connecting to the tank. The procedure used to put this method into practise will vary with the type of fittings used.

This is more important for Master tanks, which have a vapour outlet for the pilot burner. This action will prevent a build-up of ice at the pilot burner jet, and which may in some cases cause total blockage of the jet.

### 8.4 Fuel Tank Nitrogen Pressurization

The burner has an operating pressure range of 350-1000Kpa, (50-145 PSI). Flying a hot air balloon with the fuel pressure below 450KPA requires care due to the reduced burner power output. In order to provide increased fuel pressure during cold weather, fuel tanks may be pressurized with nitrogen.

The nitrogen used must be from a regulated supply, capable of providing a pressure of between 0-1000KPA, (0-145PSI) to the fuel tank.

Nitrogen is added to the tank through the liquid feed valve on the tank until the desired pressure level is reached.

Sufficient master tanks must remain nitrogen free and be easily identifiable for vapour pilot light operation.

**NOTE:** The maximum fuel tank pressure must not exceed 1000KPA, (145PSI). The maximum fuel tank pressure must not exceed 700KPA, (100PSI), if the tank is to be stored in a pressurized state.

**CAUTION:** A fuel tank that has been pressurized with nitrogen becomes unusable for vapour withdrawal for supply to pilot

burners, as the nitrogen occupies the vapour space at the top of the tank.

**NOTE:** It is recommended that any fuel tank which has been pressurized with nitrogen is labelled as such, and that extra care is taken with the use and storage of the tank.

When fuel tanks, which have been pressurized with nitrogen are warmed, the fuel pressure will rise more rapidly than that of an unpressurized tank. Care must be taken to ensure the maximum safe working tank pressure is never exceeded. This may be achieved by ensuring that tanks to be stored are not pressurized to a pressure greater than 700KPA, (100PSI).

**NOTE:** It is not a good practice to pump fill a tank through the fill limiter while the tank is pressurized with nitrogen. There is a danger that the pressure in the tank could build even higher as the tank fills and cause the pressure relief valve to activate.

Before refuelling a tank which has been pressurized, The nitrogen content must be expelled by opening the fixed liquid level gauge and bleeding off vapour for several minutes. This will reduce the vapour pressure of the tank to normal and alleviate any problems which may be caused by high pressure during the filling process. Care must be taken to ensure this is done in a suitable safe location.

If tanks to be stored are pressurized to a pressure higher than 700KPA, the pressure must be reduced, and this may be done by opening the fixed liquid level gauge, (bleed valve), and allowing vapour to escape until the tank pressure is reduced to a suitable level. Care must be taken to ensure this is done in a suitable safe location.

This venting procedure may take ten minutes or so to reduce the pressure back to normal tank pressure. When using this procedure, the same precautions must be taken as when refueling the tanks.

**NOTES:**

**SECTION 9 - SUPPLEMENTS**

9 - 2

**NOTES:**

9 - 3

**NOTES:**